



www.sanlidaarchery.com
www.sanlidaoutdoor.com



DRAGON X8 OWNER'S MANUAL

Safety

- This is a powerful compound bow and should be handled with care. Never aim the bow at something you do not intend to shoot. Please ensure your shooting area is clear and there is nobody within the area.
- Ensure that the grain of your arrow is no less than 5 grains per the bow's peak draw weight. (1 grain = 0.0648g).
- Inspect the bow before use to ensure that there is no damage on the arrows or the bow itself.
- Make sure that the arrows are of suitable length for the set draw length on the bow. Failure to do so may result in injury to yourself and/or damage to the compound bow.
- If any visible damage has occurred to the compound bow, immediately stop using the product and seek help at your local archery shop.
- Use correct shooting posture to prevent arm injuries from the string hitting the arm.
- NEVER DRY FIRE! Dry firing compound bows results in damage to the bow and possible injury to the person shooting the bow.
- Ensure there is enough shooting space to use the bow in a proper manner.
- Sanlida Archery gives no permission for using this bow illegally.

Maintenance

- Some necessary maintenance will be required. Please pay close attention to the string, cable slide, limbs, limb pocket, bow handle, cams, and cable slide rod etc. These parts are essential to the bows operation and therefore should be inspected routinely to ensure the safe operation of the bow.
- The bow string and the cable should be replaced once a year or after several thousand shots. If there is any fraying or splitting strands on the bow string or cable, immediately stop using the bow and replace the string or cable. Make sure to apply bowstring wax weekly to the bowstring and cable in order to increase the lifespan of the bowstring and the cable.
- When the bow is stored, make sure there is no dust, water, or debris on the bow (especially on or within the cams). Never dry the bow off using heat.
- If the bow has been shot in rain then the bow should be re-lubricated. Re-lubricating the bow will prevent friction of the string when drawing the bow.
- Inspect all the screws on the bow periodically. Change or tighten screws if necessary.
- Do not store your bow in any wet or hot conditions; this includes storing the bow outside or within a hot car.
- Inspect every part of the bow before each use.

Dragon X8 Component Diagram

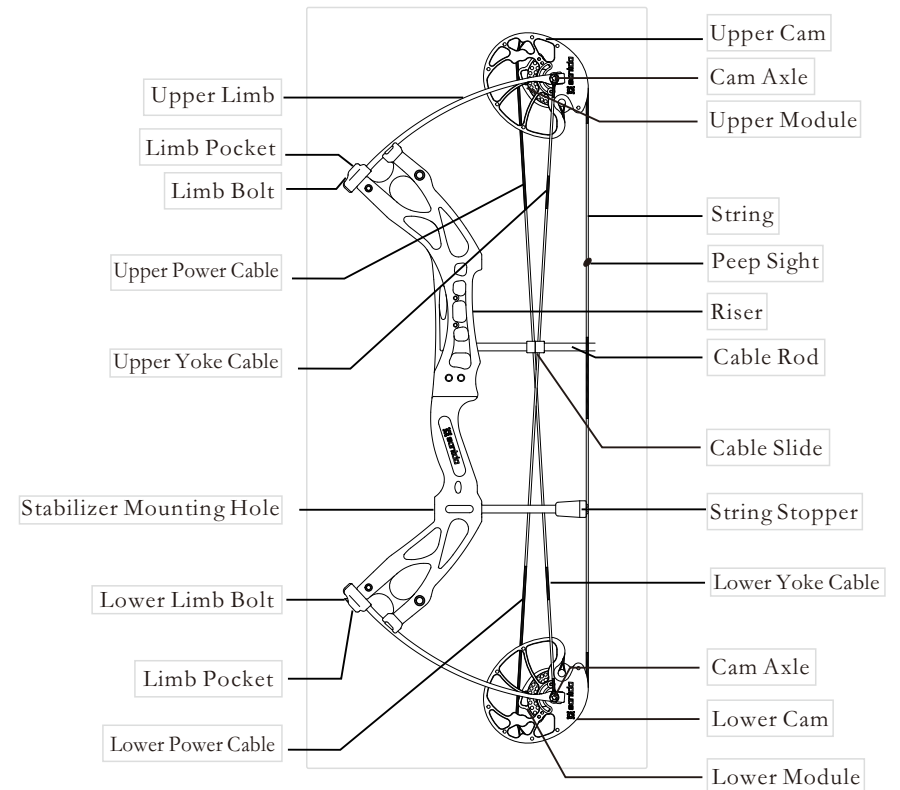

Cam System

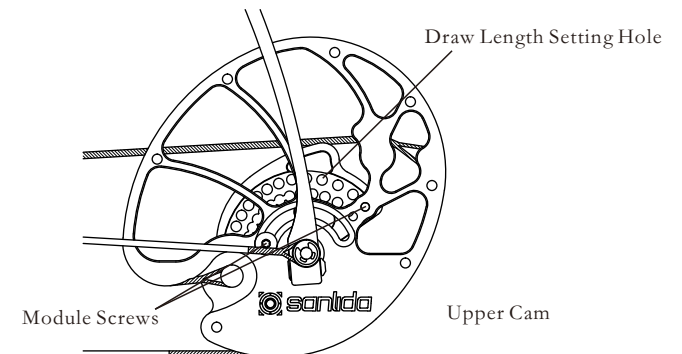

Fig.1

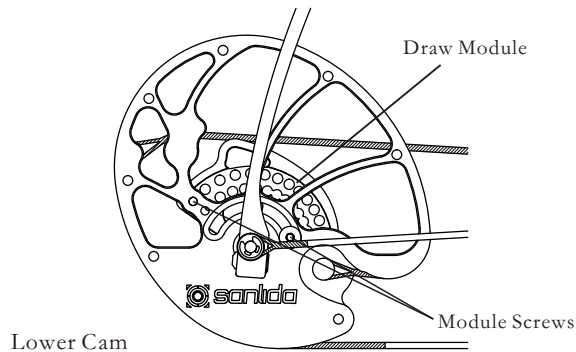

Fig.2

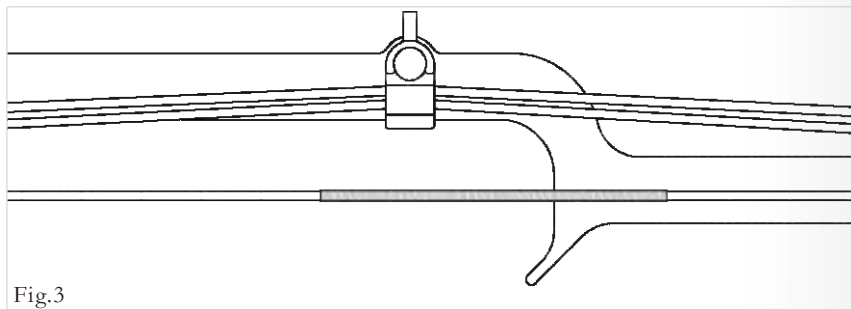

Fig.3

Cross of Cables

- This bow is equipped with a Dual-Cam system.
- The Dual-Cam system can be adjusted by rotating the cam module to the different positions.
- The bowstring and cables should be symmetrical between the top and bottom cams.
- The cable slide has grooves built in to prevent the two cables rubbing and fraying. (Fig. 3)

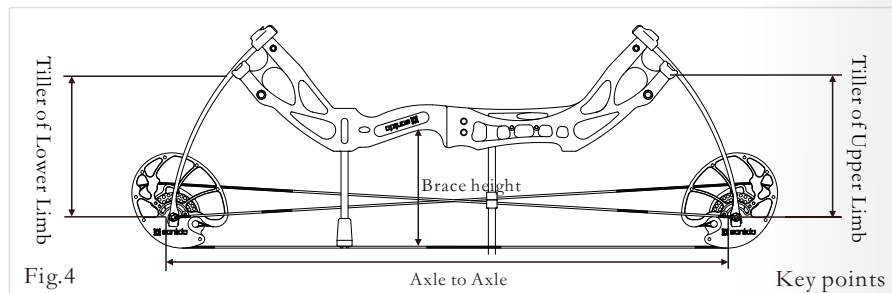

Fig.4

Axle to Axle: The distance between one of the cam axles to the other cam axle.

Brace Height: The distance between the deepest (bottom) part of the grip and the string.

Tiller: The difference between the distance of the top limb (rear face) and the string as compared to the same measurement of the bottom limb (rear face) and string.

(See Fig.4)

Bow Press Tool

- The bow must be properly setup and tuned initially. This includes the initial setup and adjustment of the brace height, cams, bowstring, and ensuring that the bow and its parts are not broken or damaged. This will ensure the maximum performance of the bow.
- Cam synchronization means the stop peg on both cams engage simultaneously. If the top and bottom cams are engaging at different times, then the cams are unsynchronized.
- We recommend that the bow is setup for a single person, and the setup takes place after the accessories have been installed. Changing accessories can cause the bow to become unsynchronized.
- If the upper and lower cams are out of synchronization, then the length of the bowstring will need to be adjusted. Instructions on how to use the bow press will be included below.

It is very important that the bow press is used correctly.

- Make sure you have chosen the correct bow press that will make taking out or changing the string and cables easier.
- Do not press the limb against the supporting pole.
- For a split bow limb, the fingers of the bow press should hold the end of the limb. This will prevent the bow from slipping out of the press while compressing the limbs. The fingers of the bow press should also have the proper length to allow the rotation of the cam when compressing the bow.
- The bow limb must be placed correctly on the fingers of the bow press without twisting the limb. Twisting the limb could result in the bow falling out of the press or causing injury. (Fig. 5)
- Do not excessively bend the bow. Excessively bending the bow could result in damage to the bow, injury to yourself, and other serious accidents.
- Do not attempt to use a bow press without the proper training.



Draw weight Adjustment

The draw weight of this bow can be adjusted.

- In order to adjust the draw weight of the bow, turn the limb bolt either clockwise or counterclockwise. Turning the limb bolt clockwise will tighten the draw weight; turning the limb bolt counterclockwise will decrease the draw weight. Turning the limb bolt one full rotation will increase or decrease the draw weight by 3-5 lbs.

- When adjusting the draw weight, the upper and lower limb bolts must be rotated the same amount.

-To ensure the limbs are tightened the same amount, measure the vertical distance from the string to the limb pocket bolt; this is called the projection distance. If the projection distance of the upper limb is the same as the projection distance of the lower limb, then the cams should be synchronized. (Fig. 6)

- Do not back the limb bolt out too much when decreasing the draw weight. The peep hole (Fig. 6) allows you to see the limb bolt while adjusting. Stop decreasing the draw weight when you see the end of the limb bolt in the peep hole.

Increase the Draw Weight in a Clockwise Direction

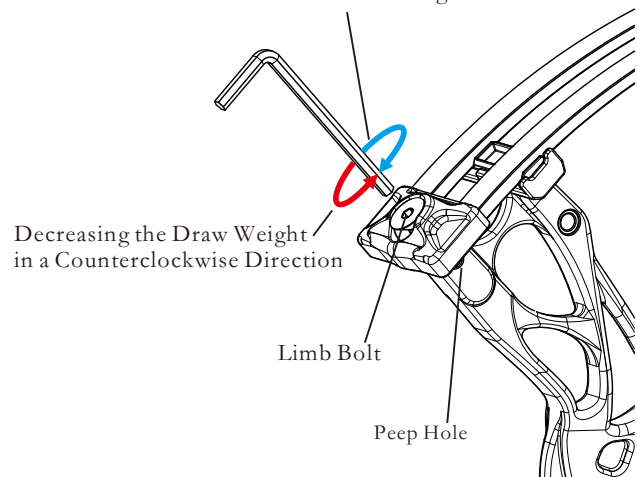

Adjustment of the draw length

To adjust the draw length, loosen the module screws first, adjust the upper and lower cams to the same module fixing holes (Fig. 7 & Fig. 8), then tighten the module screws.

Ensure that the upper and lower cams are set to the same fixing hole so the cams rest in the same position.

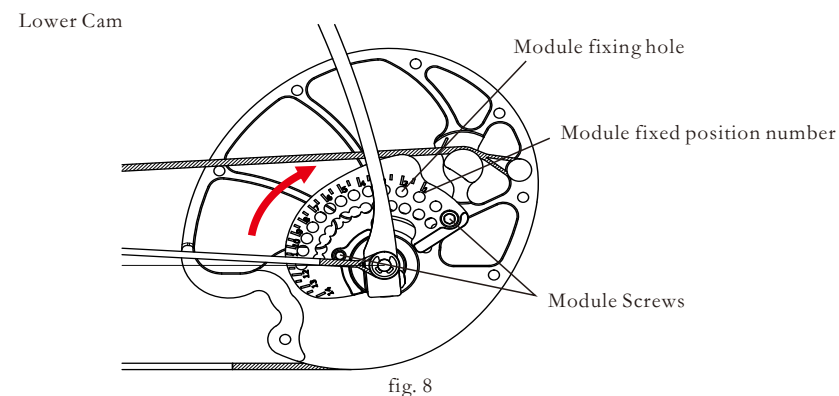
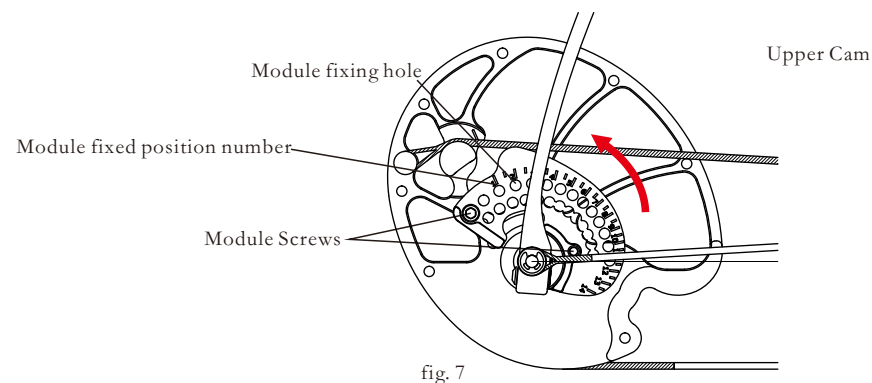

Correspondence Table
- Between Module Fixed Positions, Draw Lengths and Draw Weights -

Module Fixed Position Numbers	Maximum Draw Weight(70# Bow as the Sample)	IBO Draw Length (Inch)
1	70.0	31
1.5	69.4	30.5
2	68.8	30
2.5	68.6	29.5
3	68.3	29
3.5	67.5	28.5
4	67.1	28
4.5	65.9	27.5
5	64.7	27
5.5	63.8	26.5
6	62.8	26
6.5	61.4	25.5
7	59.9	25
7.5	58.4	24.5
8	57.4	24
8.5	55.6	23.5
9	53.9	23
9.5	52.1	22.5
10	50.8	22
10.5	49.9	21.5
11	49.8	21
11.5	49.8	20.5
12	49.8	20

12.5	49.8	19.5
13	49.8	19
13.5	49.7	18.5
14	49.7	18

Adjust the bow

The greatest impact of whether or not the compound bow will be effective is both the correct setup process and the person using the bow.

When the string stops at the draw stoppers located on both cams at the same time, this means that the bow is synchronized (Fig. 9). If the string stops on one cam before the other, this means the compound bow is out of synchronization and will need to be adjusted.

The best time to adjust the compound bow synchronization is after the accessories have been installed. This is recommended as the bow attachments will change the center of gravity after they are installed.

Below are some situations that may occur and the recommended solution for each situation:

Situation 1: When the axle to axle is longer, the lower cable is attached to the cam draw stopper, but the upper cable is not.

Solution: Twist the lower cable. This will make 3mm adjustments on the gap between the cable and the groove with each twist (rotation) of the cable.

Situation 2: When the axle to axle is shorter, the lower cable is attached to the cam draw stopper, but the upper cable is not.

Solution: Loosen the lower cable. This will make 3mm adjustments on the gap between the cable and the groove with each twist (rotation) of the cable.

Situation 3: When the axle to axle is longer, the upper cable is attached to the cam draw stopper, but the lower cable is not.

Solution: Twist the upper cable. This will make 3mm adjustments on the gap between the cable and the groove with each twist (rotation) of the cable.

Situation 4: When the axle to axle is shorter, the upper cable is attached to the cam draw stopper, but the lower cable is not.

Solution: Loosen the lower cable. This will make 3mm adjustments on the gap between the cable and the groove with each twist (rotation) of the cable.

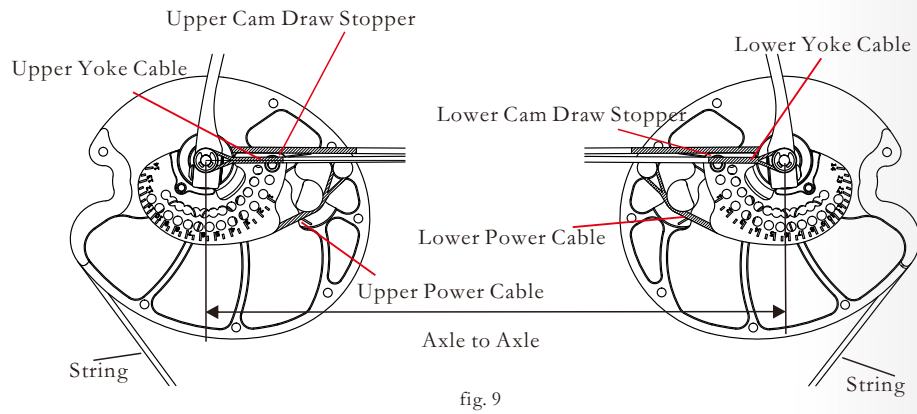

This bow uses international standards for the holes for bow accessories (Fig. 10).

Arrow Rest: There are standard screw holes for the arrow rest (Hole A). The lower edge of the arrow rest bracket should be parallel with the sight window.

Bow Sight: There are standard screw holes and hole gaps for the bow sight (Hole B), which can be fitted for all available compound bow sights on the market.

Stabilizer: Hole C is used for attaching the stabilizer and the bow sling.

Install the accessories

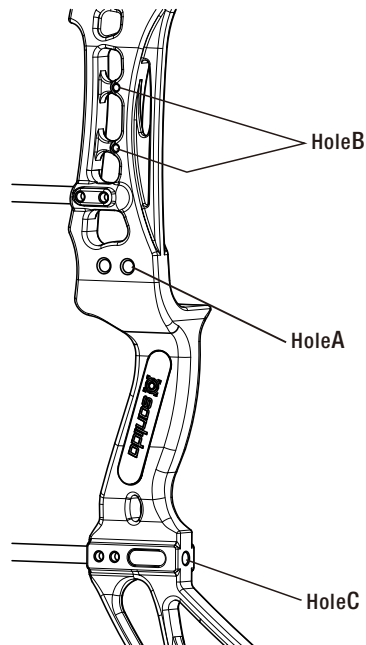

fig. 10

Product Specification

Axle to Axle (inch)	30"
Brace Height (inch)	6.5"
Draw Weight (lbs)	0~70lbs;
IBO Draw Length (inch)	18"~31"
Color	Vista Camo;Black
IBO Speed (Fps)	310
Let-off	70%~80%